



info@kip.tm



www.kip.tm



+99312 451777
+99362 991212



ABOUT COMPANY

Our company was founded in 2021. KIP Engineering holds a distinct position in its industry and is a confident business that is expanding quickly. We successfully oversee projects from the outset, through the phases of planning, execution, and commissioning, and all the way through to the project's completion. The company holds a prominent position in the services industry, providing cutting-edge technological solutions and services to its partners and clients that keep up with the times. The goals, needs, and preferences of the client form the foundation of the business. Our goals revolve around our capacity to deliver to clients the best possible solutions in terms of scope, effectiveness, and suitability under the pertinent circumstances in the shortest amount of time, along with post-purchase guarantees that include free technical support and consulting.

Our team of highly skilled specialists and engineers enables us to conduct in-depth analyses of markets and procedures within the industries we work in. Public sector representatives and private industrial organizations are among our company's clientele.

KIP Engineering has established itself in a wide range of industries. We deal with IT technologies, offering our own in-house developed products along with the option of integrating them with those of our international and domestic partners. Our work is presented in the textile, food, agricultural, and household chemical industries. We undertake projects in the industrial sector.

Our determination to create a highly productive process and solve complicated problems lead us to continuously grow and explore new frontiers, enhancing our skills and making devoted partners and friends.





Location: Industrial Area in north side of Ashgabat

Status: Active production

Engineering Period: March 2022 - August 2022

Product: PP yarns

Our company had coped with the huge challenge on recovering of CF / BCF machine of Rieter Pathfinder 222. Detailed data on what kind of jobs we had performed on this project you can find on the page 26 of current document. Now production line of filament yarns is fully functioning.

We own this factory in cooperation with- Partner Company which produce plastic goods in Ashgabat since 2019.

The plant is equipped with equipment from the world famous Austrian company «Rieter».

Continuous filament yarns are used for a large number of applications, such as big-bag sewing yarns, nets, ropes or belts. Additional to this CF yarns used for weaving fabrics for furniture apartments. This production site produces CF yarn of various numbers and colors. The range of produced yarn consists of the following numbers:

- 2124 dtex;
- 2290 dtex;
- 4000 dtex.



OUR WORK SPACE

CF / BCF YARNS PRODUCTION PLANT





FERTILIZERS PRODUCTION PLANT

Location: Industrial Area in Mary

Status: Active production

Construction and equipping period: August 2022 – December 2022

Product: Compound fertilizers

KIP Engineering has a partnership on producing compound fertilizers. Our side is responsible for control of use of technology, processing, maintenance of equipment.





SERVICES AND PRODUCTS

KIP Engineering offers professional solutions in the fields as "industrial engineering" and "IT and Telecommunications»

- Turnkey design, manufacture and implementation of ACS and MES systems;
- Design and preparation of infrastructure for a manufacturing enterprise;
- Selection of production equipment and calculation of parameters of peripheral installations, incl. steam generators, water treatment facilities, etc.;
- Supply of special technical means and components: lubricants, spare parts;
- Comprehensive services for the commissioning of production lines, machineries: beginning from the assembly of mechanical, electrical parts to the full commissioning and startup;
- Assembly, installation, connection of power cabinets and control cabinets;
- Programming and reprogramming of PLC and HMI

- RFID Solutions
- Design And Implementation Of Telecommunication Systems
- Design And Implementation Of IT Infrastructure Of Enterprises
- Supply And Commissioning Of Network And Server Equipment



CLIENTS



TÜRKMEN
DEMİR
ÖNÜMLERİ

arçalyk

TäçHil



SADA
SUW

Bereketli Dökün
Agro Fertilizator

JEYHUN
KABEL



Aýazbaba

RYSGAL
M E B E L

AKPEN **mebel**

PROJECTS

 KRONES

 BERTSCH

 aerlikon
neumag

RIETER

GEA

STK MAKINA
GIDA MAKINALARI IML SAN TIC LTD STI.

 imgo

 EKTAM

 GZ
国信机械
GUOXIN MACHINERY

 ÖZ-MAK

DEALERSHIP

 MENNAN
MAKINA

 ZEBRA

Airpol

 INTERFLON

 LG

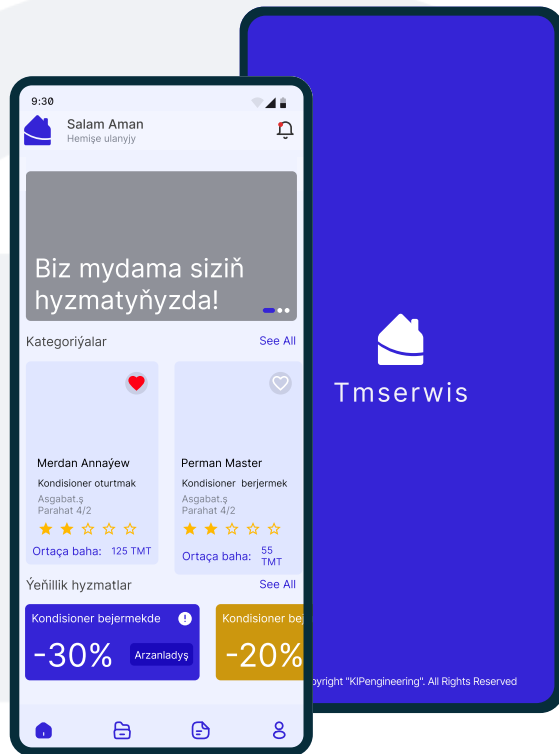

RFID

Automation of warehouse and trade processes.
Automation of activities based on RFID technology - reliable,
efficient and easy to use.

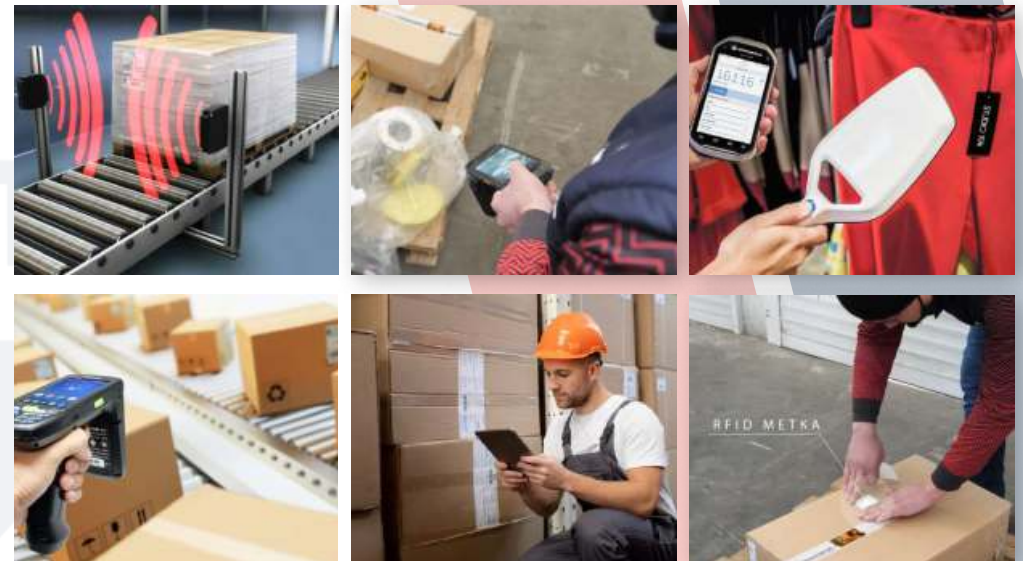

"TmSerwis"

Use the services of service specialists throughout Turkmenistan,
assessing their characteristics by quality, geographic proximity and
availability using the TmSerwis mobile application.



"LEMMER"

is an electronic document management designed under the standards of Turkmenistan.

The product offers flexible personnel and document management, and the built-in chat helps in building relationships among employees. The toolkit of the service also contributes to the organization of work process.

- Personal management
- Internal corporate chat
- System of projects and tasks
- Cloud storage

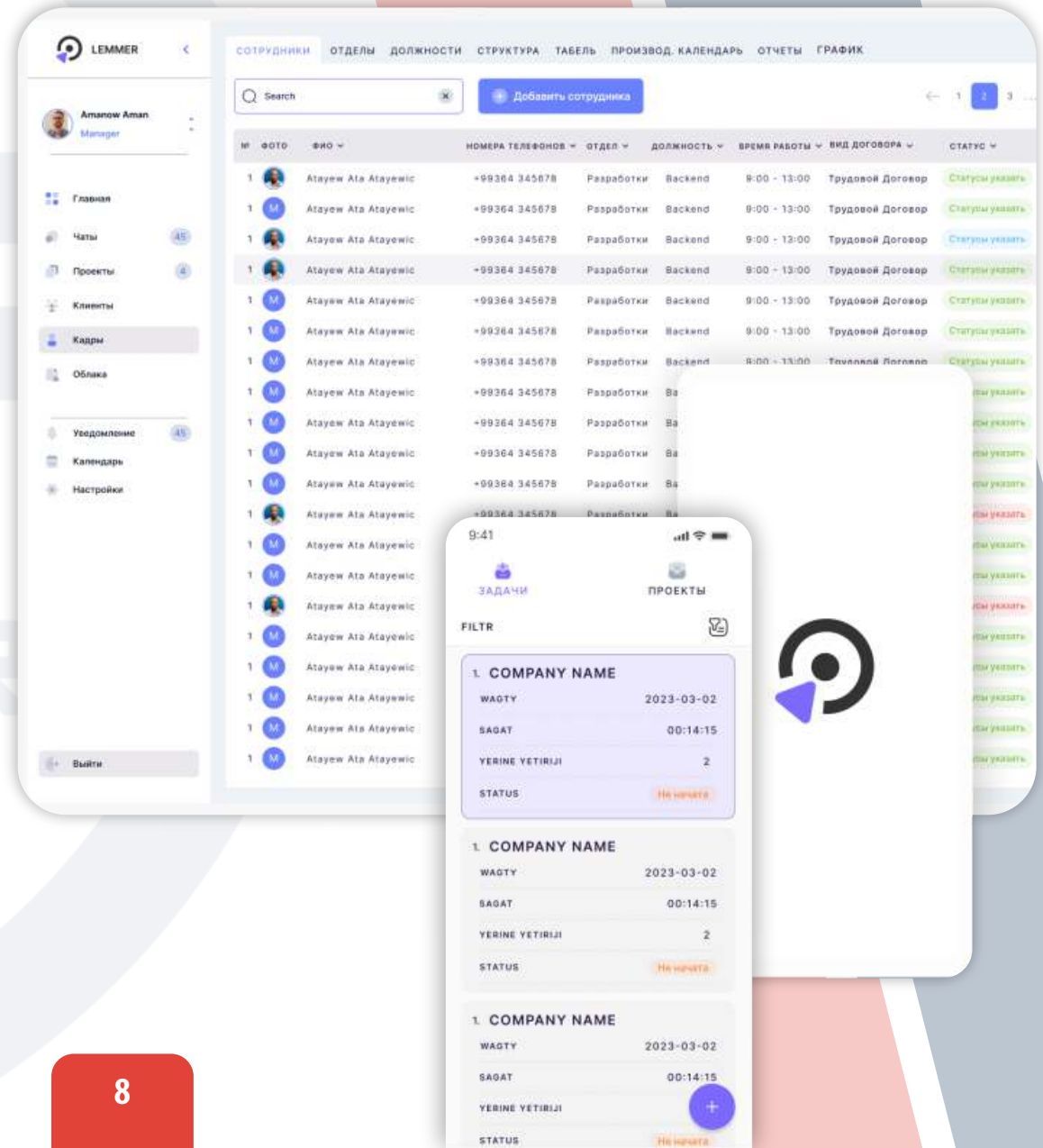



We offer our clients advanced solutions for the IT infrastructure of the facility, which includes the design of cable routes, the selection of network, server equipment and specific software solutions for secure, efficient data exchange inside and outside the local network, video surveillance, computerization and automation of work and business processes.

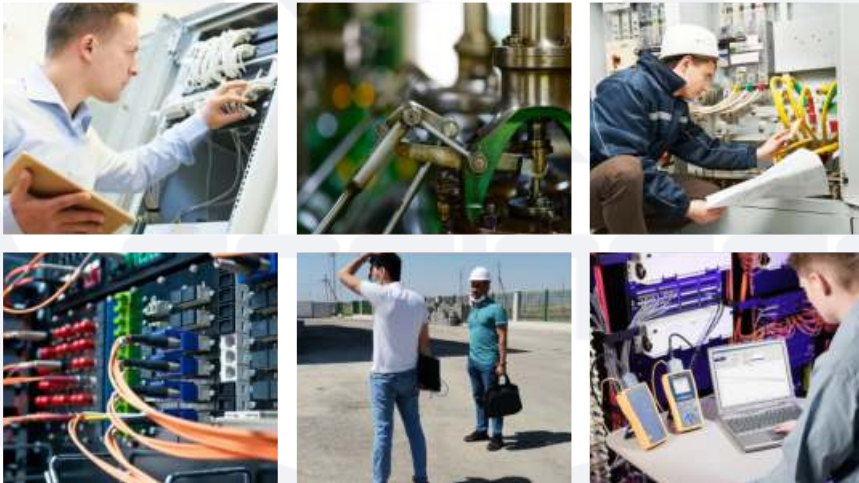

IT INFRASTRUCTURE & CCTV

ARCHALYK

ARCHALYK IS THE №. 1 MANUFACTURER OF SOFT DRINKS IN TURKMENISTAN

From January 2021 to present

Full technical maintenance of IT infrastructure , including the server, network devices, computers, and other office supplies.

«OWADAN AYNA»

FERTILIZER PRODUCTION PLANT

Design and creation of IT infrastructure from scratch: cable routes, video surveillance, network infrastructure



AK DAMJA

MANUFACTURER OF SOFT DRINKS
From May 2022 to present

Full technical maintenance of IT infrastructure , including the server, network devices, computers, and other office supplies.



«SAHABATLY»

June- July 2022

A set of works to create a network infrastructure.

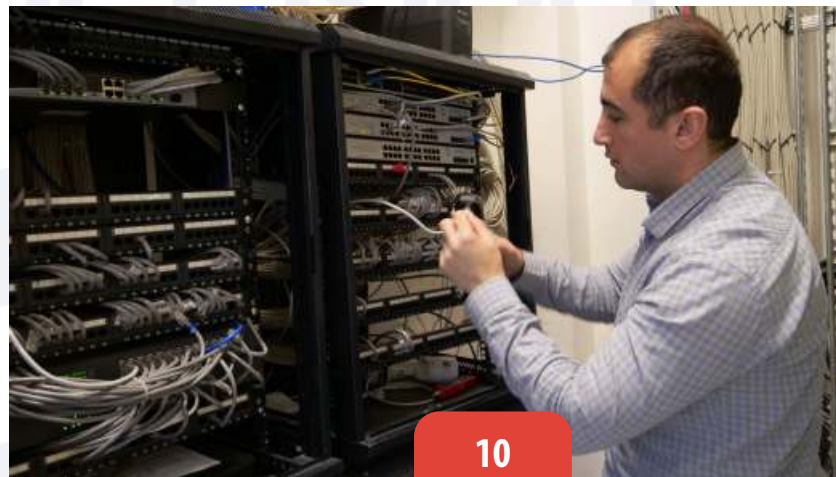

IT INFRASTRUCTURE & CCTV

«OWADAN ADA»

PLANT FOR THE PRODUCTION OF TEXTILE PRODUCTS

May - September 2022

Design and creation of IT infrastructure from scratch: cable routes, video surveillance, network infrastructure.

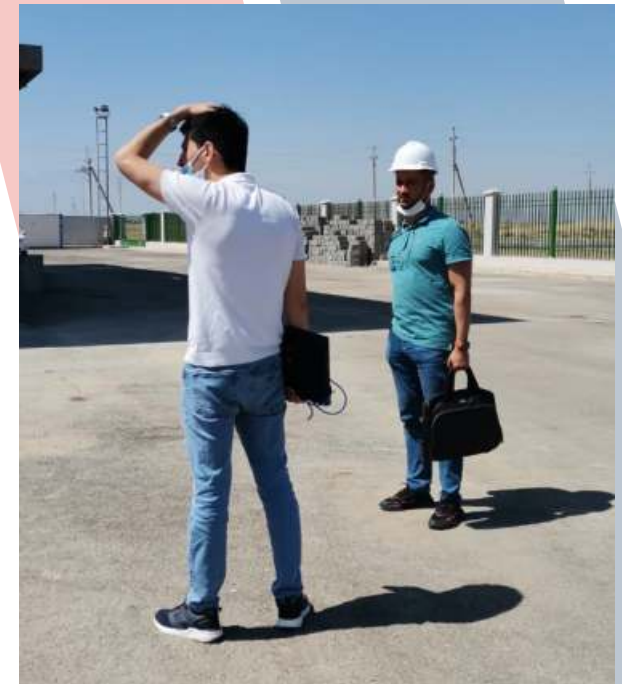



AVIATION PERSONNEL TRAINING SCHOOL

September - December 2022

A set of preventive and restoration work on network infrastructure.

ASHGABAT INTERNATIONAL AIRPORT

October 2023

Audit of Airport IT systems.

«TURKMENISTAN» AIRLINES

May 2023

A series of maintenance and repair tasks for network infrastructure.

ASHGABAT INTERNATIONAL AIRPORT

August 2023

Restoring the Swiss AMOS system to full operation by removing all errors, both physically and conceptually.





INDUSTRIAL ENGINEERING SERVICES & SUPPLIES

Nowadays, cost reduction and rational use of time is the main key to success.

Therefore, KIP Engineering always follows a systematic approach in organization of the work process. Our motto: "Only the right actions and nothing in excess." Following this motto, "KIP Engineering" ES carefully plans the steps of the production process, which progressively leads to a timely and high-quality completion of the work.

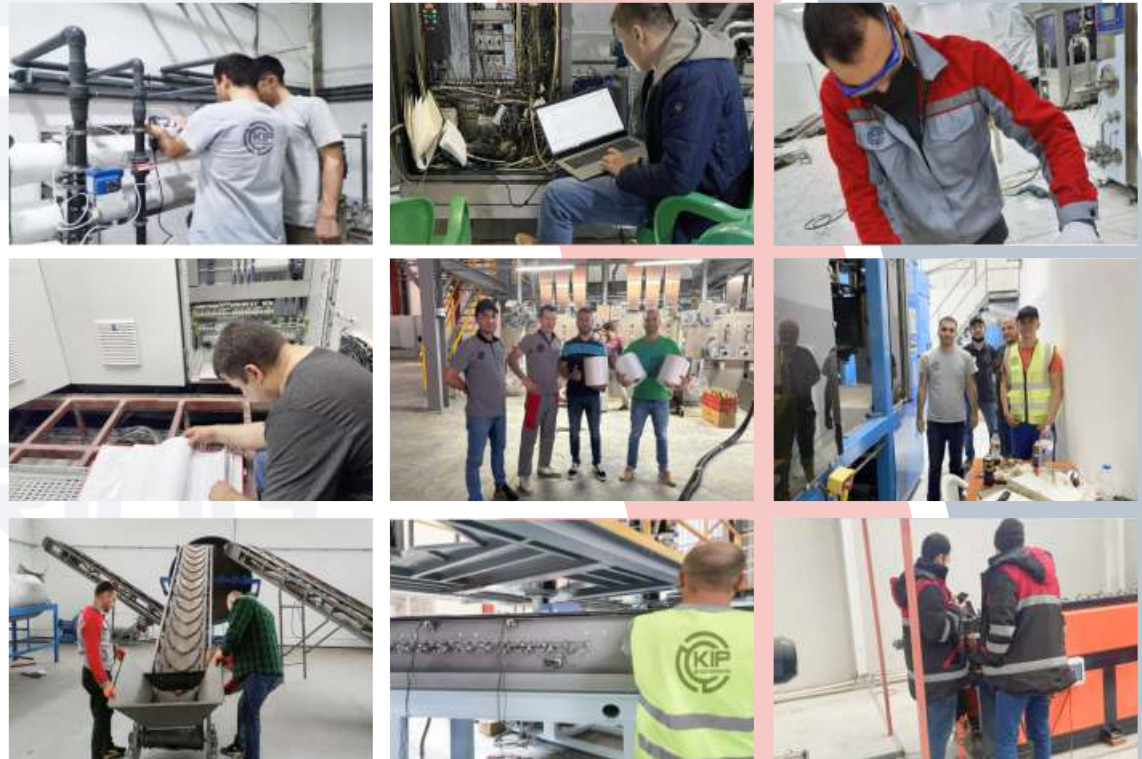



INDUSTRIAL PROJECTS

ARCHALYK SMI

August 2021

Emergency stop of the machine for reasons unknown to the supplier, as a result, the engineering team decided to reset to factory settings, make a new recording of a program, set parameters starting «from zero».

METALLURGICAL COMPLEX ATOMAT SPA

August 2021

Restoring the metal-cutting machine of the Italian manufacturer Automat SPA to its working condition by changing parts of the program in Simatic S7 after the factory components of equipment has been replaced, which caused loss of technical and functional properties of equipment.



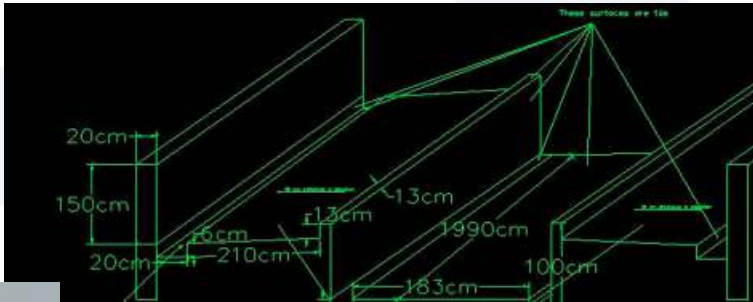

INDUSTRIAL PROJECTS

SAHABATLY ENGINEERING PROJECT OF THE MILKING ROOM

August 2021

Together with European consultants from the EBRD we have carried out the project on renovation of a milking plant for milk production, which includes routing of cables, pipes, milking equipment, milk collection.

MAHMAL ZIP KRONES

September - December 2021

The company's specialists calculated the suitable engineering approach and managed to recreate the operating parameters of the line, compiled from the installations of various European suppliers. After the line has been transferred from the working site in Germany, part of the working documentation, particularly manuals, diagrams and layouts of control and measuring devices & automatic equipment were missing.



The company's specialists successfully coped with more than a difficult task. For example, the program has been corrected on some installations due to replaced components instead of factory ones.



Adjusting and startup procedures on bag making machines DakoT-101,T-101A



INDUSTRIAL PROJECTS

TACH HIL DAKO T-101, T-101 A

September 2021

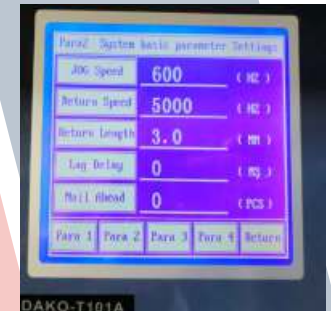

SABYRLY ISH AUTOMATIC MOLDING MACHINE EKin

September 2021- may 2022



Our company is a technical partner of Sabyrly Ish & Penaly Yol. company Specialists of KIP engineering qualitatively and timely perform all types of service work on the equipment which produces plastic items.





INDUSTRIAL PROJECTS

SADA SUW IMGO

October 2021- May 2022



Juice manufacturing facility. Turnkey completion of the work was successfully achieved. The Erensan steam generator's installation and operation. Installation and commissioning of a reverse osmosis station. Mechanical, electrical, signal line assembly. Laying air, gas and stainless steel communications. Commissioning works. Successful commissioning of the facility.



Installation and launch of a line for the production of fruit juices in glass containers using IMGO equipment.

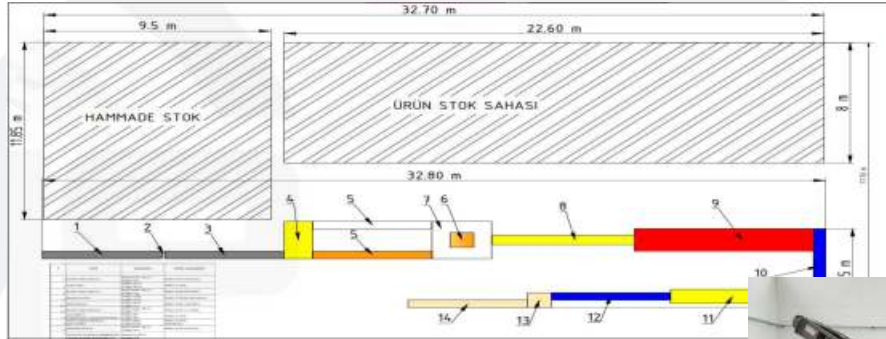

OWADAN AYNA

October 2021- February 2022

The project has been performed on a turnkey basis. Line for the production of encapsulated fertilizers, compiled by equipment from various Turkish suppliers.

Greenfield engineering project.

Selection of technology, equipment, installation and commissioning of the line. The line fully commissioned in June 2022 upon arrival of raw materials to produce test batch of item products.

ASLY HALAL GUOXIN

November 2021- January 2022

Design of the line for sorting MSW (Municipal solid waste separation). The most effective solutions have been selected based on: Characteristics of the Customer's work site; analysis of MSW fractions delivered to the territory and prospects for subsequent use of sorted out MSW.

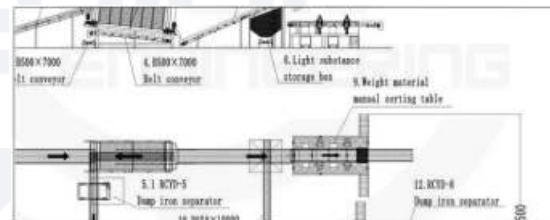



JEYHUN KABEL XINMING

February 2022



Diagnostics of the assembled line for improper installation. Correction of installation defects. Commissioning of the line producing electric cables of small section.





OWADAN ADA OERLIKON NEUMAG. ATLAS COPCO, ERENSAN, CARRIER

February 2022- July 2022



Laying of air, gas, water communications.
Installation at design positions, connection, adjusting and start-up procedure of the Erensan steam generator, Atlas Copco compressors, Carrier chiller. Mechanical assembly, electrical and signal connection, commissioning of the BCF Yarn S8 plant by Oerlikon Neumag, the world leader in this field



INDUSTRIAL PROJECTS

AK DEPE HASYLY BERTSCH

March - may 2022

LINE PRODUCING MILK AND MILK-RELATED PRODUCTS OF AUSTRIAN BRAND

Welding work during the installation of cable channels, stainless steel electrical cabinets. Laying power and signal cables. Connection of peripheral equipment, main equipment which produces milk and milk-related products and other mechanisms involved in the technology.

ARCHALYK KRONES

May - August 2022

Equipment and assembly of Krones company. The company's specialists together with a foreign process engineer, having studied the technological scheme, documentation of the elements have created a program on TIA Portal 15. The project was successfully put into operation in July 2022.





DAT MENI

August 2022

Work on the modernization and repair of a Turkish-made cereal packing machine and a corrosion-resistant salt packing machine. It was necessary to replace the drive chains, clean the pneumatic system, update the electrical wiring, troubleshoot the hot knife, and rearrange the actuator positions on the salt packing machine.

INDUSTRIAL PROJECTS

TACH HIL OZMAK

August 2022

SELECTION, SUPPLY AND EXPANSION OF PRODUCTION.

At the request of the Client, on the basis of the T3, an extensive study of the equipment market in Turkey has been carried out and the machines that were optimal in terms of price-quality ratio have been selected. The company's specialists supported on the competent delivery, as well as installed and put into operation machines for the production of polyethylene garbage bags with a cord, bags for packing broiler chickens and solid bags with decor.





TURKMENDEMIRONUMLERI ATOMAT SPA AT 830 E HD

February 2023

Our experts performed preventative and diagnostic maintenance on actuators, measuring devices, and electrical equipment. During the course of our work, we reinstalled the hardware and software of the ATOMAT AT 830 E HD roll lathe, which has not operated since 2018. We also bought a CNC for the machine.



BEREKETLI DOKUN FERTILIZERS SCU

February 2023

Phased development of the SCU fertilizer production project:

Creation and execution of the fertilizer production SCU launch concept. Our organization handled the logistics and customs clearance for a unique non-serial piece of equipment that was purchased for this project. The installation process was completed in compliance with all technical requirements.





INDUSTRIAL PROJECTS

AUTOMATIC EQUIPMENT
CONTROL SYSTEM RESTORATION

YEDIDOĞAN GARTEMANN & HOLLMANN

February 2023

Our team fixed errors in the Gartemann & Hollmann control program based on the client's demands. Slave devices in the Profibus industrial network were deactivated during the work, along with the software functional block that debugged the automatic servo control and the block that calculated time intervals, the mark's speed of movement, the servo drive's current rotation speed, and the block that handled the human-machine interface.

TURKMEN TAJIRCHILIK ŞAKAR MAKINA

August 2023

ASSEMBLY AND COMMISSIONING OF THE
PRODUCTION LINE ŞAKAR MAKINA LUBRICANTS.

The tasks completed included installing and assembling the oil product bottling line, installing cable channels, installing the power connection cable to the equipment, and installing pipe communications to supply goods for bottling.



DURLI GAP RIETER

March - August 2023



Machine was in difficult condition without many of technical documents. Enormous volume of works had trained our engineering team very well

The following local tasks were completed:

- Engineering analysis of extra and required parts and their on-the-spot delivery.
- Installing machines mechanically; conducting public and air. communications; laying and connecting power and signaling devices; and replacing and repairing higher structure components.
- Configuring network connections between visible machine components and control equipment.
- Repair of the dosing system, textured machine operation, and AHU system.
- Establishing communication using the industrial data transfer protocol.
- Commissioning the complete production line and receiving the final product; installing and commissioning the compressor equipment.





TURKMENDEMIRONUMLERI M.C.M

INDUSTRIAL PROJECTS



RESTORING THE FUNCTIONALITY OF THE CNC MACHINE IN MECHANICAL SHOP OF THE METALLURGICAL PLANT IN OVADAN DEPE.

August - September 2023

Workers determined the root causes of the issue, finished replacing malfunctioning parts and equipment, ran system diagnostics, loaded software, and the machine's functionality was restored.

MIWELI OBA

FRUIT JUICES IN PET CONTAINERS
September - October 2023



Installation of equipment::

- Construction of communications pipes;
- The initial functionality's expansion to include the equipment the customer needs for PET preform and bottling production;
- A thorough commissioning and commissioning process.